

Click fendering system





Since 1973, Wilks has been at the forefront of the UK marine industry in the supply of fendering to the world's leading marine companies and directly meets the needs of boat builders, chandlers and retail customers.

Wilks stock a wide range of boat fendering / rub rail profiles to meet the demands of a variety of vessels as well as pontoon fendering specifically designed for use as a dock bumper upon moorings, landings and floating pontoons.



Click Fendering System

Click is the latest boat fendering system from Wilks and has been developed to provide a quick and simple installation without compromise to impact resistance. The Click system consists of a rigid PVC track and flexible UV stabilised PVC body to provide a quick fit fendering system with hidden fixings.

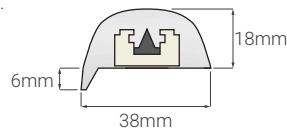

CLICK 38

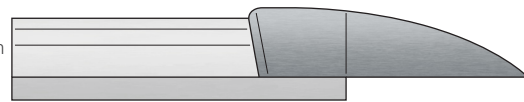
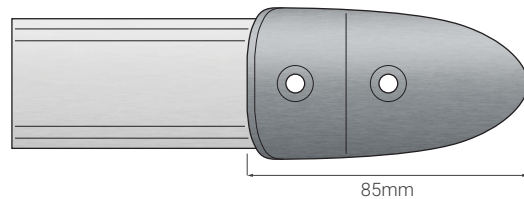

CLICK 50

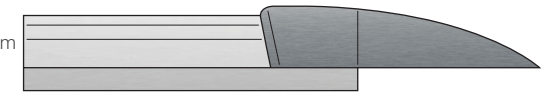
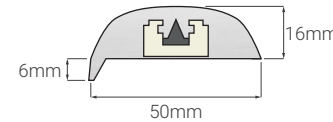
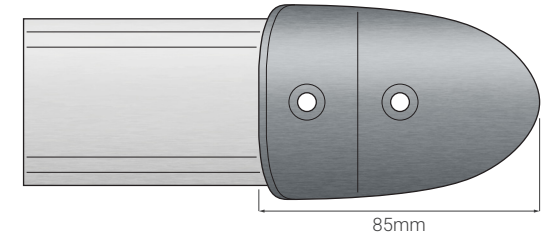

CLICK 80

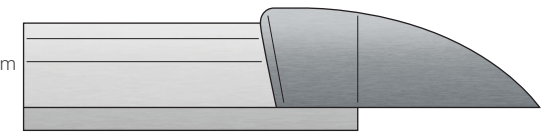
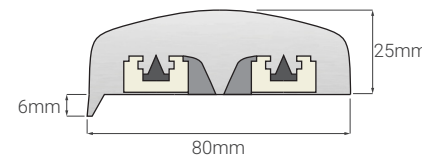
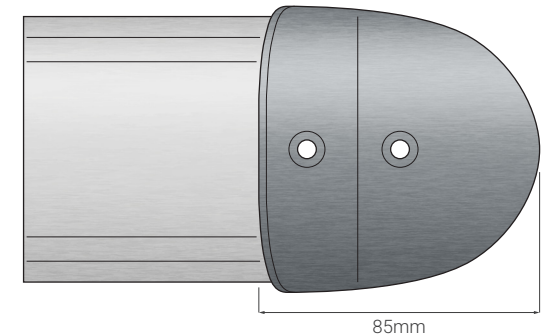





FLEXITEEK

Beautifully engineered synthetic decking
and marine products.

CONTACT US

T +44 (0)1621 869609
E sales@wilks.co.uk
W www.wilks.co.uk
W www.flexiteek.com
A Woodrolfe Rd, Tollesbury,
Essex, CM9 8RY

FOLLOW US

 wilks.co.uk
 [Wilks_UK](#)
 [wilks-rubber-plastics-mfgs-co-ltd](#)